

User
experience by
Hispack
challenges

Hispack
2018
PACKAGING, PROCESS
& LOGISTICS

Fira Barcelona



mtn®

Montana Colors

Spray paint since 1994

ASOCIACIÓN ESPAÑOLA
DE AEROSOL



**Ergonomía, diseño y experiencia de uso
a través del aerosol.**

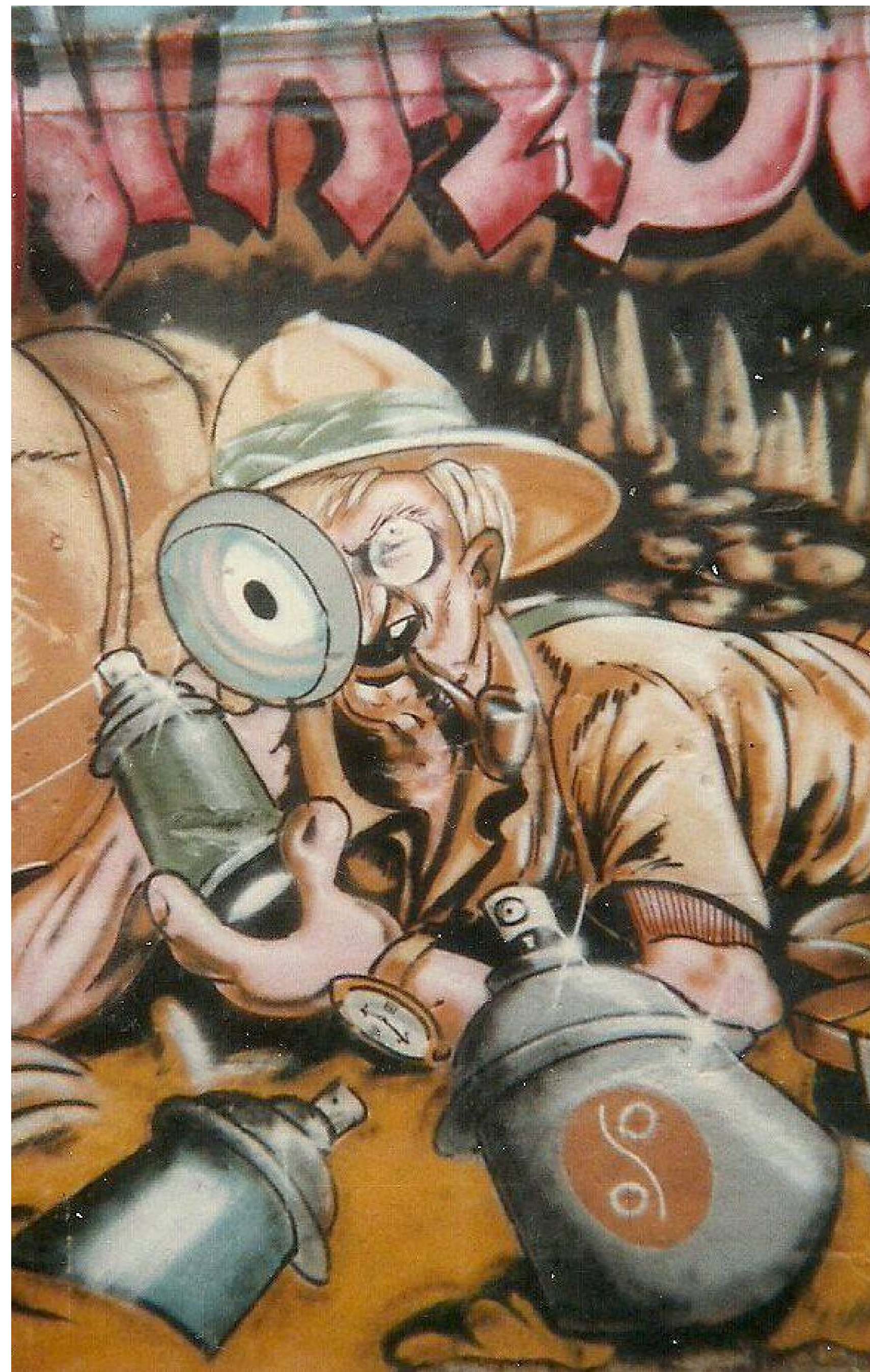





PARTICIPANTES

Cruze	Zürich	Suiza	Cisco	Barcelona	España
Use	Zürich	Suiza	Tomaszbk	Barcelona	España
Tnt	Basel	Suiza	Fase	Barcelona	España
Cole	Dormunt	Alemania	Zee	Barcelona	España
Won	Munich	Alemania	Heiz	Barcelona	España
Cow Boy 69	Munich	Alemania	Save	Barcelona	España
Can 2	Luzerna	Suiza	Dios	Barcelona	España
Atom	Zürich	Suiza	Cash	Barcelona	España
Kane	Heidelberg	Alemania	Zent	Barcelona	España
Time	Heidelberg	Alemania	Shan	Barcelona	España
Opak	París	Francia	Der	Barcelona	España
Jiwee	París	Francia	Recs	Barcelona	España
Lady Fancie	París	Francia	Slader	Barcelona	España
Musa	Barcelona	España	Jetsan	Barcelona	España
Popay	París	Francia	Posiek	Barcelona	España
Honet	París	Francia	Sunsak	Barcelona	España
Swy	Madrid	España	Taran	Barcelona	España
Kami	Madrid	España	Sutil	Barcelona	España
Faze 2	Madrid	España	Dae	Barcelona	España
Chop	Madrid	España	Wem	Barcelona	España
Mast	Madrid	España	Knock	Barcelona	España
Sore	Madrid	España	Sip	Barcelona	España
Koe	Madrid	España	Stracks	Barcelona	España
Tony	Madrid	España	Phoco	Barcelona	España
Sus 033	Madrid	España	Risot	Barcelona	España
Edu	Madrid	España	His	Barcelona	España
Metro	Gerona	España	Diez	Barcelona	España
Zeo	Barcelona	España	Krash	Barcelona	España
Apro	Gerona	España	Spark	Barcelona	España
Soyez	Gerona	España	Ziner	Barcelona	España
Ome	Gerona	España	Zoser	Barcelona	España
Shet	Gerona	España	Cane	Barcelona	España
Zeus	Mataró	España	Caos	Barcelona	España
Heroe	Mataró	España	Rostro	Barcelona	España
Fat	Mataró	España	Txiki Trepax	Barcelona	España
Ire	Mataró	España	Frank	Barcelona	España
Lee	Barcelona	España	Eso	Barcelona	España
Esbel	Tarragona	España	Zetacks	Barcelona	España
Poseidon	Barcelona	España	Edu	Barcelona	España
Clink	Barcelona	España	Vandal	Barcelona	España
Aspuc	Barcelona	España	Taz	Barcelona	España
Serok	Barcelona	España	Zeke	Barcelona	España
Rashie	Barcelona	España	Seone	Barcelona	España
Foster	Barcelona	España	Nibelungo	Barcelona	España
Moockie	Barcelona	España	Roza	Barcelona	España
Kapi	Barcelona	España	Zoe	Barcelona	España
Sendy's	Barcelona	España	Tone	Barcelona	España
Puke	Barcelona	España	Cesart	Barcelona	España
T-zack	Tarragona	España	Melo	Barcelona	España
Lexy	Barcelona	España	Sei	Barcelona	España

Precios Entradas:

- SABADO 25-6-94	800 Ptas.
- DOMINGO 26-6-94	900 Ptas.
- PAX (SAB. 25 y DOM. 26)	1.500 Ptas.

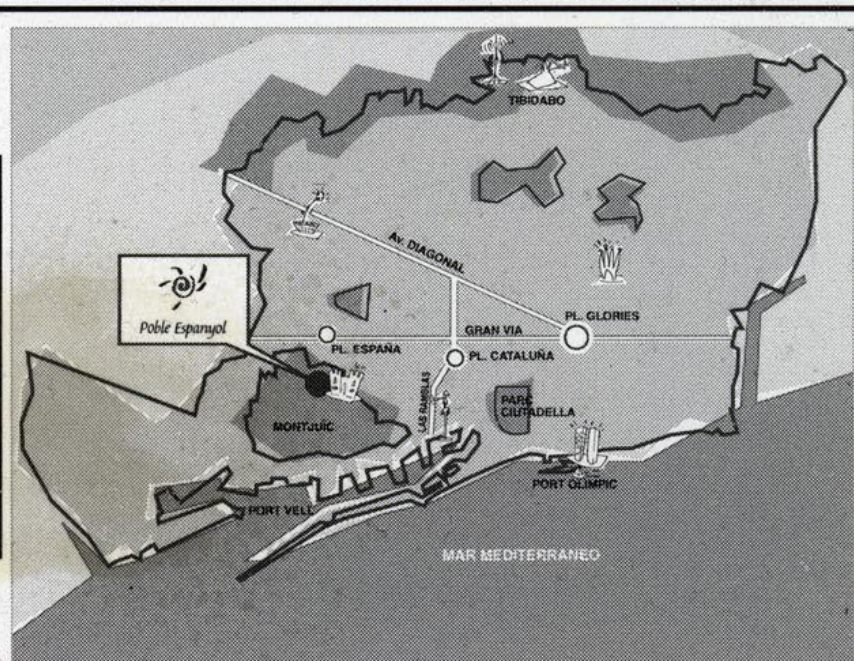

1ª MUESTRA INTERNACIONAL DE AEROSOL ART

MONTJUÏC
Marqués de Comillas, s/n
BARCELONA / ESPAÑA
DIAS 25 y 26 DE JUNIO 1994

ORGANIZA: **CD FIRES** Ctra. de Esplugues, 88 - 08039 BCN
Tel.: 280 40 02 - Fax: 280 23 72

COLABORACION ESPECIAL

FONT AGUDES del MONTSENY
discos castelló barcelona
GO THE ORIGINAL
GAME OVER SHOP
Felton SPRAY



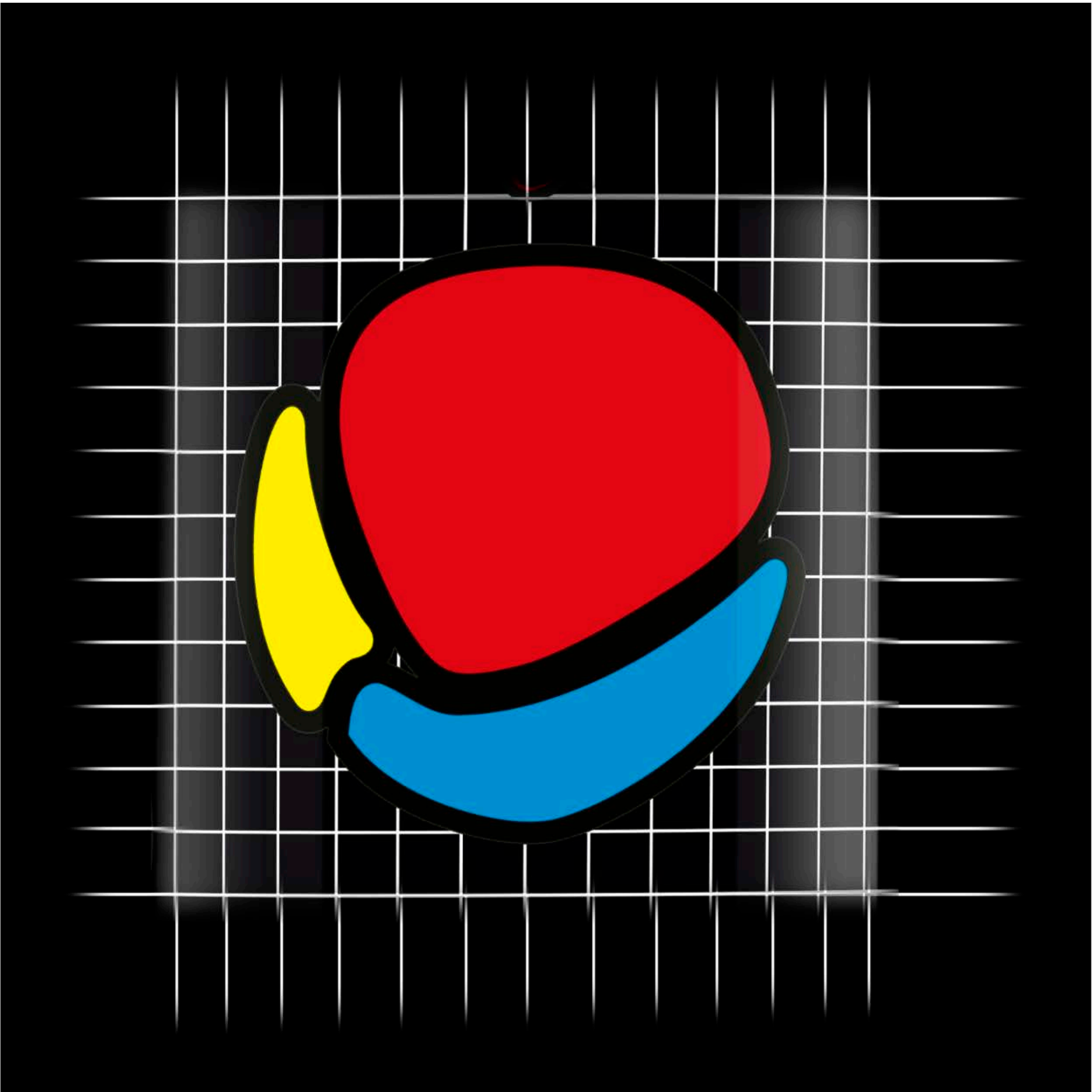

mtn[®]
de MONTANA COLORS



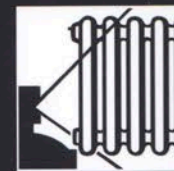

MONTANA COLORS, S.L. - c/ Vila Cinca 54 - 08208 SABADELL - Barcelona
Tel. (93) 777 55 75 - Fax (93) 777 63 75

montana PINTURA
PAINT
SPRAY

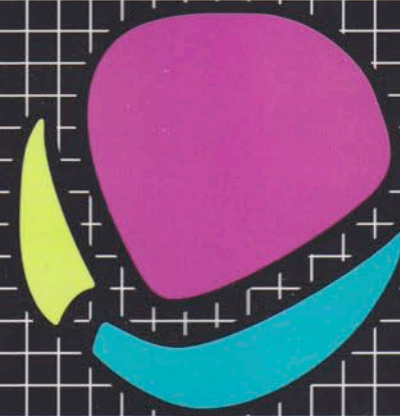

**CARTA DE
COLORES**

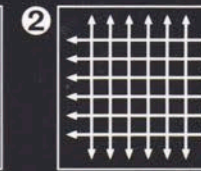

E 1 Limpiar y desengrasar bien el objeto a pintar. Agitar el bote enérgicamente durante un minuto, después de empezar a oírse el ruido del mezclador. 2 Pinte con el envase en posición vertical en pasadas rápidas y finas a una distancia de unos 25 cm., dejando secar durante 10 minutos entre capa y capa. 3 Al finalizar el pintado invierta el bote y pulverice unos segundos en esta posición, hasta que deje de salir pintura por el difusor, evitando así la obstrucción de éste.

F 1 Nettoyez et dégraissez bien l'objet à peindre. Agitez vigouremment le récipient pendant 1 minute après d'écouter le bruit du mélangeur. 2 Pulvériser avec le récipient en position vertical avec des passes rapides et fines a une distance de 25 cm. Laissez sécher chaque couche environ 10 minutes. 3 Terminée l'opération, renversez le récipient et pulvériser quelques secondes dans cette position, jusqu'au moment où la peinture cesse de sortir du diffuseur, évitant ainsi l'obstruction.

USA 1 Clean and degrease thoroughly the object to be painted. Shake vigorously the container for one minute time from hearing mixer noise starting. 2 With the container in vertical position, proceed painting by applying fast and thin sprays from a distance of 25 cm. Let coating dry some 10 minutes. 3 After finishing painting, reverse container and proceed spraying a few seconds in that position until paint stops emerging from difusor, thus avoiding it getting clogged.

Todos los colores se suministran en envases de 200 ml. y 400 ml.

Para mayor información solicite ficha técnica.



INFLAMABLE



NO CONTIENE COLO
RANGE DEL COLO

PRECAUCION - Recipiente a presión. Proteger de los rayos solares y no exponer a temperaturas superiores a 50°C. No perforar ni incinerar incluso después de su uso. No vaporizar hacia una llama o cuerpo incandescente. No fumar. Mantener fuera del alcance de los niños. No aspirar la pintura pulverizada y no morder las superficies pintadas.

PRECAUTIONS - Récipient sous pression. À protéger contre les rayons solaires et à ne pas exposer à une température supérieure à 50°C. Ne pas percer ou brûler, même après usage. Ne pas vaporiser vers une flamme ou un corps incandescent. Ne pas fumer. Tenir hors de portée des enfants. Ne pas respirer les vapeurs. Ne pas mordre les surfaces peintes.

CAUTION - Pressurized container. Protect from sunlight and do not expose to temperatures exceeding 50°C. Do not pierce or burn even after use. Do not spray on a naked flame or any incandescent material. No smoking. Keep out of reach of children. Do not breath spray.

Esmaltes

Brillantes







 R-1016 Amarillo Limón	 R-1017 Melocotón	 R-1021 Amarillo Claro
 R-3017 Rojo Fiebre	 R-3020 Rojo Claro	 R-3022 Almíbar
 R-5005 Azul Oscuro	 R-5012 Azul Celeste	 R-5015 Azul Marino
 R-V4 Verde Claro	 R-V5 Verde Lutecia	 R-6016 Verde Oscuro
 R-7016 Gris Antracita	 R-V7 Crema	 R-1001 Beige

 R-1028 Amarillo Medio	 R-1034 Amarillo Pastel	 R-2003 Naranja Pastel
 R-4003 Violeta Erika	 R-4006 Púrpura	 R-4007 Cereza
 R-5014 Azul Tempestad	 R-5015 Azul Medio	 R-5018 Azul Turquesa
 R-6018 Verde Valle	 R-6019 Verde Pálido	 R-6021 Verde Pastel
 R-8001 Ocre	 R-8002 Marrón Tostado	 R-8017 Marrón Tabaco

 R-V8 Azul claro	 R-3014 Frambuesa	 R-4001 Lila
 R-2004 Naranja	 R-2010 Buñono	 R-2012 Caramelo
 R-4008 Violeta Signal	 R-4009 Morado	 R-V1 Violeta Pálido
 R-5020 Azul Océano	 R-5021 Azul Caribe	 R-5023 Azul Lago
 R-6015 Verde Caspi	 R-6027 Verde Luminoso	 R-6028 Verde Selva
 R-8023 Mostaza	 R-8025 Lado	 R-3004 Rojo Burdeos

 R-6034 Turquesa Pastel	 R-V9 Albaricoque	 R-V10 Verde Menta
 R-3001 Rojo vivo	 R-3012 Arcilla	 R-3015 Rosa
 R-V2 Violeta	 R-V3 Violeta Azulado	 R-5002 Azul Ultramar
 R-5024 Azul Venecia	 R-6005 Verde Olivo	 R-6011 Verde Magenta
 R-V6 Gris Claro	 R-7040 Gris Perla	 R-7031 Gris Oscuro
 R-9010 Blanco Divinidad	 R-9016 Blanco Nata	 R-9011 Negro Brillo

Satinados

 Amarillo	 Carne	 Salmon
 Rojo	 Azul	 Verde
 Marrón	 Gris	 Manzana

Cromado

 Plata
--

Metalizados

 Plata Joya	 Galvanizado	 Oro	 Cobre
---	--	--	--

Linea Blanca

Blanco

Anti-calóricas

Blanco



Negro



Plata

Carpintería Aluminio

Blanco



Bronze



Aluminio

Parachoques, Llantas

Blanco



Plata



Negro

Fluorescentes

 Amarillo	 Naranja	 Rojo	 Fucsia	 Azul	 Verde
---	--	---	---	---	--





Montana Air
Spray paint factory & Services



Classic



HARRI CORRE

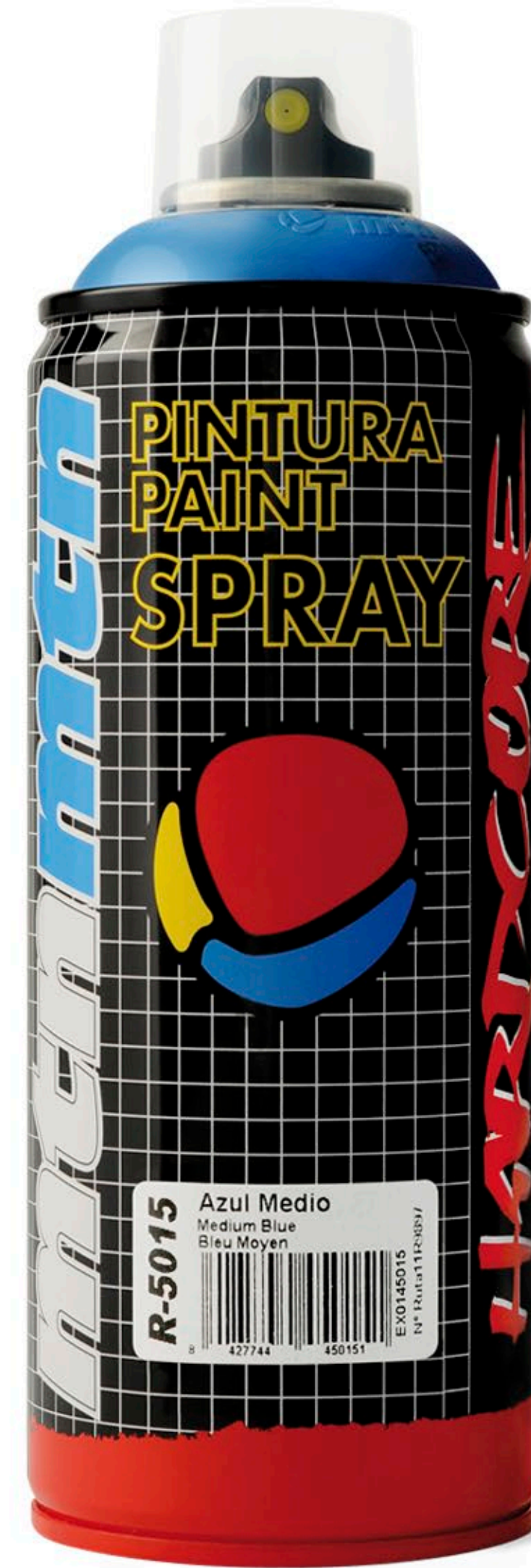

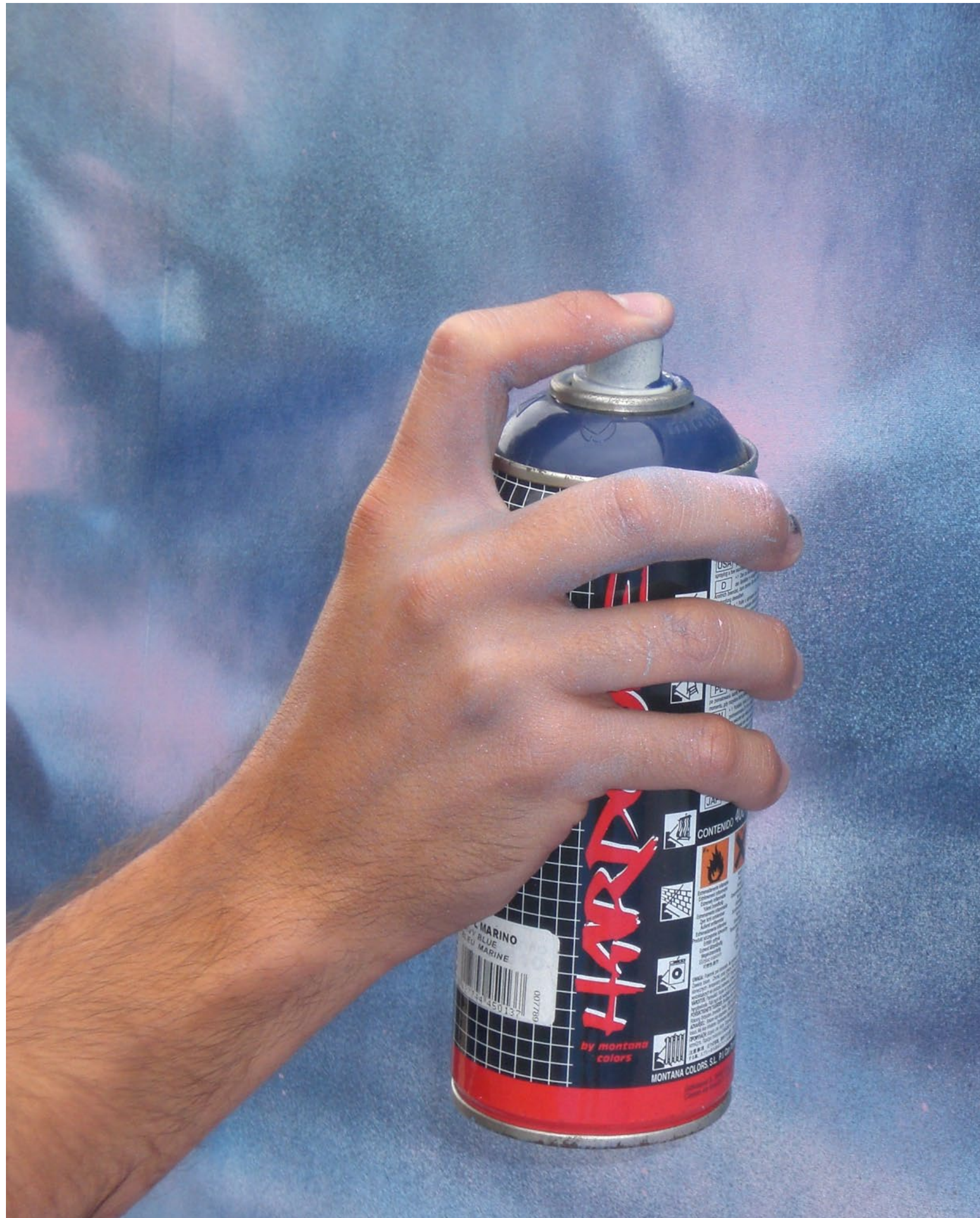



CARTA DE COLORES COLORCHART

R-9016 BLANCO NATA * CREAM WHITE	R-9010 BLANCO DIVINIDAD * DIVINITY WHITE	R-V49 AM. CALIFORNIA CALIFORNIA YELLOW	R-V20 AMARILLO FESTA * PARTY YELLOW	R-1016 AMARILLO LIMON * LEMON YELLOW	R-V11 AMARILLO GANGES GANGES YELLOW	R-1021 AMARILLO CLARO * LIGHT YELLOW	R-V1017 MELOCOTÓN PEACH	R-1028 AMARILLO MEDIO * MEDIUM YELLOW	R-1034 AMARILLO PASTEL PASTEL YELLOW
R-V26 COCOHO * COCONUT	R-V9 ALBARICOQUE APRICOT	R-V50 NARANJA SOLAR SOLAR ORANGE	R-2003 NARANJA PASTEL * PASTEL ORANGE	R-2010 NARANJA SIGNAL SIGNAL ORANGE	R-2004 NARANJA * ORANGE	R-2012 CARAMELO CHOCOLATE	R-3014 FRAMBUESA RASPBERRY	R-3017 ROJO FEBRE * FEVER RED	R-V33 ROJO COLORADO COLORADO RED
R-3027 ROJO DIABLO * DEVIL RED	R-3020 ROJO CLARO * LIGHT RED	R-3001 ROJO VIVO * INTENSE RED	R-V48 ROJO REPLICANTE REPLICANT RED	R-V18 OXIDO ROJO RED OXIDE	R-3004 ROJO BURDEOS * BURGUNDIAN RED	R-V66 ROJO TERRACOTA TERRACOTA RED	R-3007 ROJO CHEROKEE CHEROKEE RED	R-V77 ROJO NOCHE NIGHT RED	R-V122 SALMON SALMON
R-3015 ROSA PINK	R-V22 ROSA PASION * PASSION PINK	R-4003 ERKA ERKA	R-4010 MAGENTA * MAGENTA	R-4006 PÚRPURA * PURPLE	R-V51 VIOLETA REPUBLICA REPUBLIC VIOLET	R-4007 CEREZA * CHERRY	R-V25 CUERO FELT	R-4008 MORADO IRIDISE	R-4001 LILA LILAC
R-4008 VIOLETA SIGNAL SIGNAL VIOLET	R-V1 VIOLETA PÁLIDO PALE VIOLET	R-V2 VIOLETA * VIOLET	R-V3 VIOLETA AZULADO * BLUE VIOLET	R-V28 VIOLETA COSMOS COSMOS VIOLET	R-V27 VIOLETA VAMPIRO * VAMPIRE VIOLET	R-V73 AZUL AURORA AURORA BLUE	R-V13 AZUL HIMALAYA * HIMALAYA BLUE	R-V29 AZUL ÁRTICO * ARCTIC BLUE	R-V8 AZUL CLARO * LIGHT BLUE
R-5012 AZUL CELESTE * SKY BLUE	R-5015 AZUL MEDIO * MEDIUM BLUE	R-V30 AZUL ELÉCTRICO * ELECTRIC BLUE	R-5005 AZUL OSCURO * DARK BLUE	R-5002 AZUL ULTRAMAR * ULTRAMARINE BLUE	R-5013 AZUL MARINO * NAVY BLUE	R-V75 AZUL NOSTROMO NOSTROMO BLUE	R-V23 AZUL MONACO MONACO BLUE	R-5024 AZUL VENECIA VENICE BLUE	R-5014 AZUL TEMPESTAD STORM BLUE
R-5023 AZUL LAGO LAKE BLUE	R-V32 AZUL LEWIS LEWIS BLUE	R-6027 VERDE LUZ LUMINOUS GREEN	R-6034 TURQUESA PASTEL PASTEL TURQUOISE	R-5018 AZUL TURQUESA TURQUOISE BLUE	R-V5021 AZUL CARIBE CARIBBEAN BLUE	R-V14 AZUL PLANETA PLANET BLUE	R-5020 AZUL OCEANO OCEAN BLUE	R-V76 VERDE ABISMO ABYSS GREEN	R-V10 VERDE MENTA MINT GREEN
R-V4 VERDE CLARO * LIGHT GREEN	R-V24 VERDE GOLDEN GOLDEN GREEN	R-V16 VERDE PISTACHO * PISTACHIO GREEN	R-V34 VERDE GUACAMOLE * GUACAMOLE GREEN	R-6018 VERDE VALLE * VALLEY GREEN	R-V5 VERDE LITECIA * LITECIA GREEN	R-V21 VERDE QUIRÚNGICO SURGICAL GREEN	R-6016 VERDE OSCURO * DARK GREEN	R-6028 VERDE SELVA * JUNGLE GREEN	R-6008 VERDE AMAZONAS AMAZONAS GREEN
R-6019 VERDE PÁLIDO VERDE PÁLIDO	R-6021 VERDE PASTEL * PASTEL GREEN	R-6011 VERDE MÁQUINA MACHINE GREEN	R-V15 VERDE MANZANA APPLE GREEN	R-6013 VERDE CAJOLÍ KAJOLÍ GREEN	R-6003 VERDE OLIVO OLIVE GREEN	R-1013 BLANCO HUESO BONE WHITE	R-V7 CREMA * CREAM	R-1001 BEIGE BEIGE	R-V19 CAFÉ FLESH
R-3012 ARCILLA CLAY	R-V17 ARENA TENDRE TENDRE SAND	R-8001 OCRE * SAND BROWN	R-8023 MOSTAZA MUSTARD	R-V26 MARRÓN BREAKFAST BREAKFAST BROWN	R-8002 MARRÓN TOSTADO * TOASTED BROWN	R-8017 MARRÓN TABACO * TOBACCO BROWN	R-V35 MARRÓN CHOCOLATE CHOCOLATE BROWN	R-8025 LODO MUD	R-V6 GRIS CLARO * LIGHT GREY
R-7040 GRIS PERLA * PEARL GREY	R-V31 GRIS ACERO * STEEL GREY	R-7031 GRIS OSCURO * DARK GREY	R-7016 GRIS ANTRACITA * ANTHRACITE GREY	R-V78 GRIS METRÓPOLIS METROPOLIS GREY	R-9011 NEGRO * BLACK	PLATA JOYA * SILVER JEWEL	PLATA CROMADA * SILVER CHROME	ORO * GOLD	COBRE * COPPER
				AMARILLO FLUORESCENTE * FLUORESCENT YELLOW	NARANJA FLUORESCENTE * FLUORESCENT ORANGE	ROJO FLUORESCENTE * FLUORESCENT RED	ROSA FLUORESCENTE * FLUORESCENT PINK	AZUL FLUORESCENTE * FLUORESCENT BLUE	VERDE FLUORESCENTE * FLUORESCENT GREEN

DATOS TÉCNICOS

- 400 ML.
- ALTA PRESIÓN
- GRAN CUBRICIÓN
- 116 COLORES
- ACABADO BRILLANTE

TECHNICAL DATA

- 400 ML.
- HIGH PRESSURE
- GREAT CUBRITION
- 116 COLOURS
- GLOSSY FINISH

CAP SYSTEM



MONTANA VALENCIA C/CONVENTO JERUSALEM 49 TELF 963 423 581 VALENCIA@MONTANACOLORS.COM
MONTANA COLORS S.L. P.I. Clot del Tufau - 08295 Sant Vicenç de Castellet - BARCELONA - Spain - T. (+34) 938 332 787 - F. (+34) 938 330 875 - www.montanacolors.com

* TAMBIÉN DISPONIBLE EN CLASSIC (150 ML.)
ALSO AVAILABLE IN CLASSIC (150 ML.)

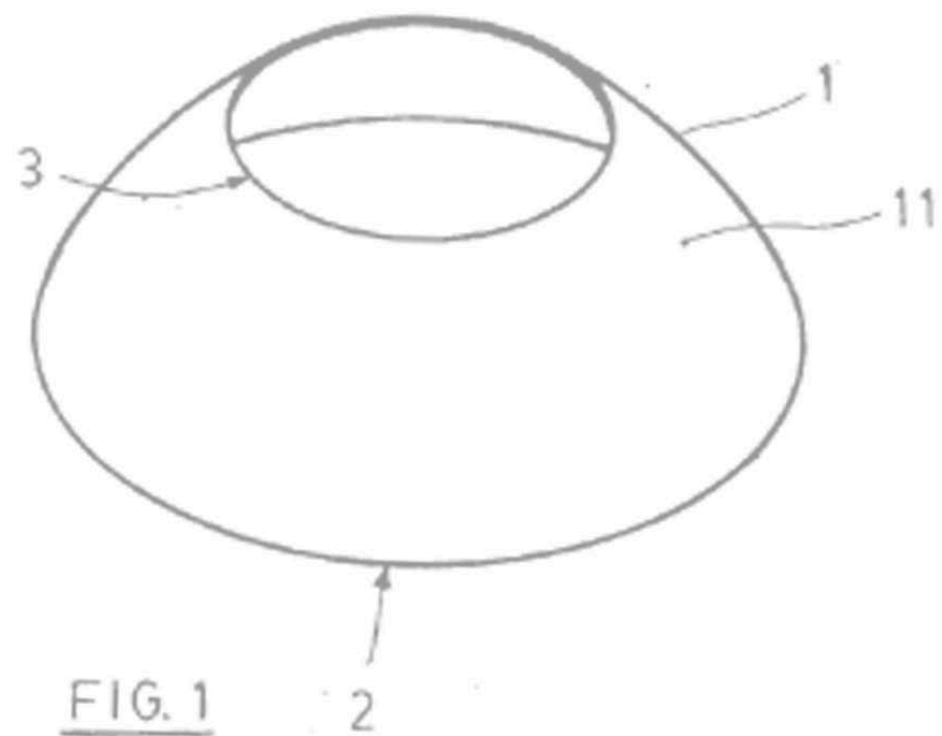

FIG. 1



① Número de publicación: **1 039 242**
 ② Número de solicitud: U 9800102
 ⑤ Int. Cl.º: B65D 83/38

⑬  OFICINA ESPAÑOLA DE PATENTES Y MARCAS
 ESPAÑA

⑫ SOLICITUD DE MODELO DE UTILIDAD

② Fecha de presentación: 16.01.98

④ Fecha de publicación de la solicitud: 01.12.98

⑦ Solicitante/s: Montana Colors, S.L.
 Pol. Ind. Can Torrella, c/ Berlín, s/n
 08233 Vacarisses, Barcelona, ES

⑧ Inventor/es: Rubio Rocabert, Jordi

⑦ Agente: Fortea Laguna, Juan José

FIG. 2

⑤ Título: Un indicador de color para contenedores de pintura en aerosol.

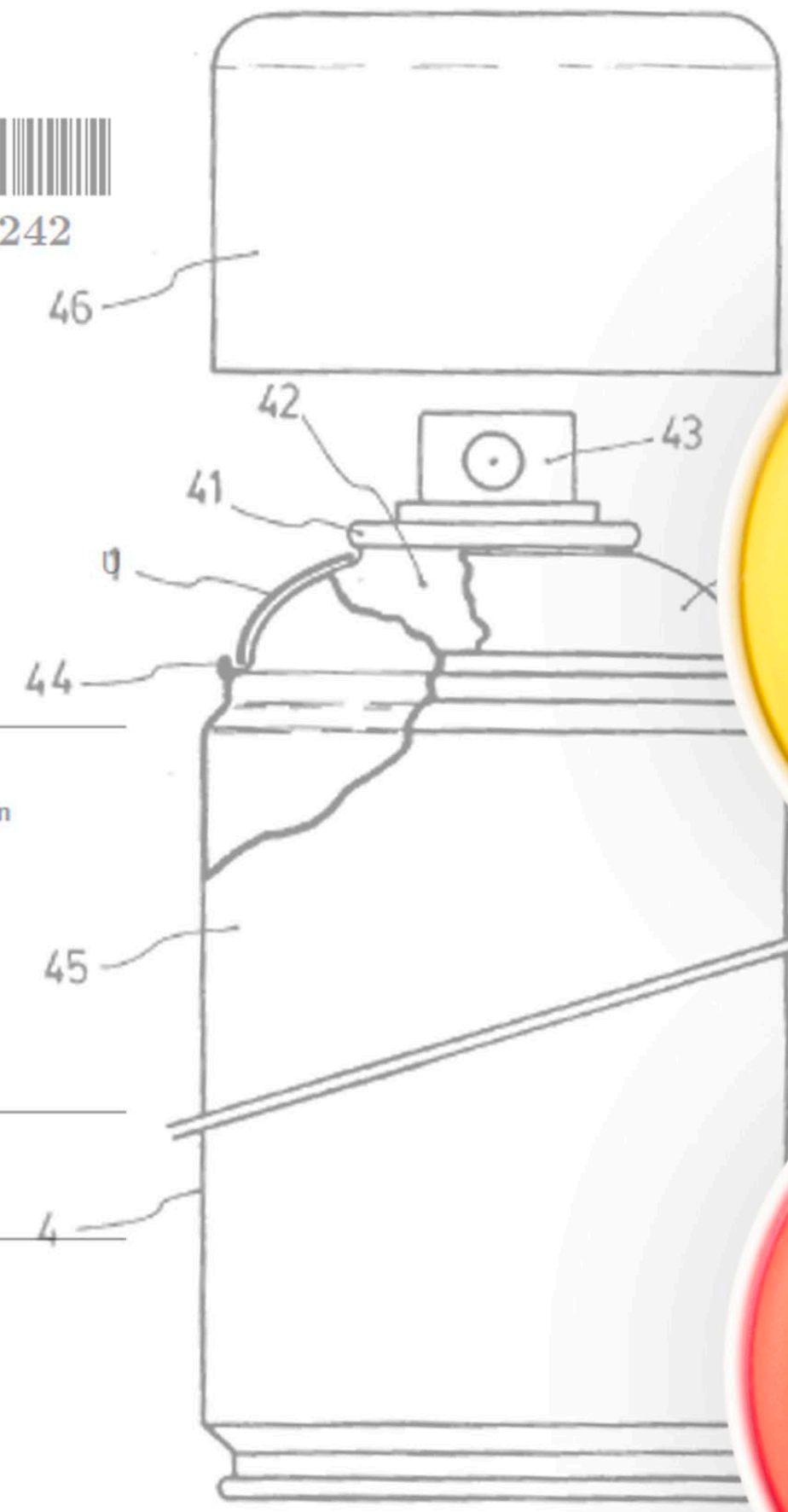















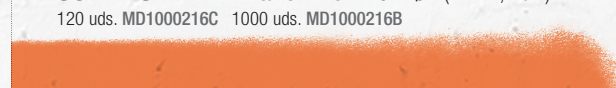

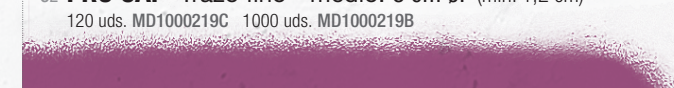



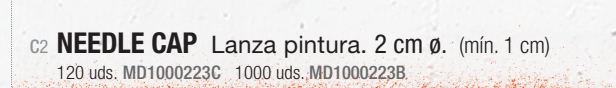

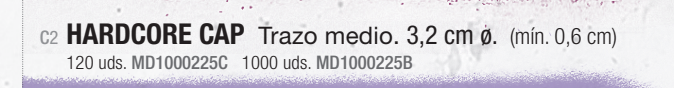



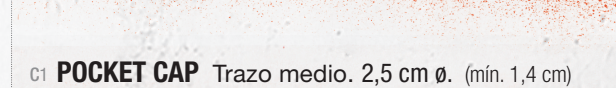

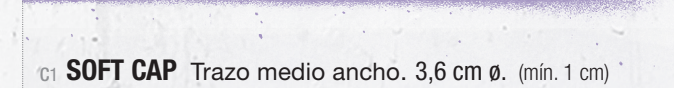

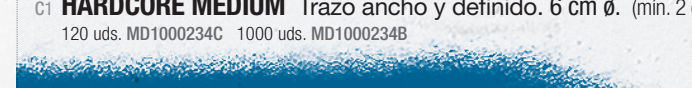



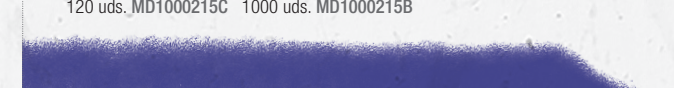

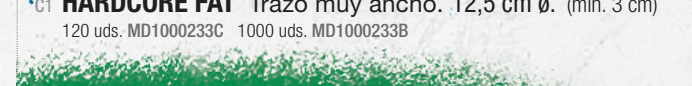

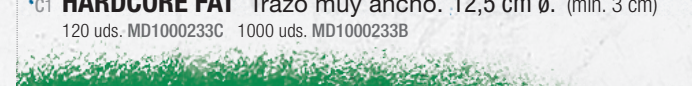

System Caps™ / Difusores

Estas medidas son orientativas y están presentadas a escala entre sí. Todos los difusores (caps) son compatibles con todos nuestros sprays.
 Experimenta con la distancia de aplicación para encontrar el tipo de trazo y grosor ideal para tu necesidad. Más información en www.montanacolors.com
 C1 - C2 Rangos de precios.

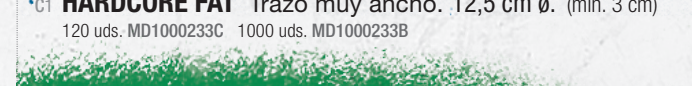

Montana Colors
 Supporting graffiti since 1994

 C2 94 CAP Trazo fino. 1,8 cm Ø. (mín. 0,8 cm) 120 uds. MD1000203C 1000 uds. MD1000203B		 C1 YELLOW UNIVERSAL Trazo medio. 3 cm Ø. (mín. 0,5 cm) 120 uds. MD1000204C 1000 uds. MD1000204B		 C1 LEGO CAP Trazo ancho. 5 cm Ø. (mín. 1,5 cm) 120 uds. MD1000304C 1000 uds. MD1000304B	
 C2 SUPER SKINNY Trazo fino. 2 cm Ø. (mín. 1,1 cm) 120 uds. MD1000216C 1000 uds. MD1000216B		 C2 PRO CAP Trazo fino - medio. 3 cm Ø. (mín. 1,2 cm) 120 uds. MD1000219C 1000 uds. MD1000219B		 C1 FAT PINK Trazo ancho. 5 cm Ø. (mín. 1,8 cm) 120 uds. MD1000210C 1000 uds. MD1000210B	
 C2 NEEDLE CAP Lanza pintura. 2 cm Ø. (mín. 1 cm) 120 uds. MD1000223C 1000 uds. MD1000223B		 C2 HARDCORE CAP Trazo medio. 3,2 cm Ø. (mín. 0,6 cm) 120 uds. MD1000225C 1000 uds. MD1000225B		 C1 NY FAT Trazo ancho. 5 cm Ø. (mín. 1,9 cm) 120 uds. MD1000302C 1000 uds. MD1000302B	
 C1 POCKET CAP Trazo medio. 2,5 cm Ø. (mín. 1,4 cm) 120 uds. MD1000214C 1000 uds. MD1000214B		 C1 SOFT CAP Trazo medio ancho. 3,6 cm Ø. (mín. 1 cm) 120 uds. MD1000213C 1000 uds. MD1000213B		 C1 HARDCORE MEDIUM Trazo ancho y definido. 6 cm Ø. (mín. 2 cm) 120 uds. MD1000234C 1000 uds. MD1000234B	
 C2 TRANSFER CAP Extractor de pintura. 2,5 cm Ø. (mín. 1,2 cm) 120 uds. MD1000235C 1000 uds. MD1000235B		 C2 TRANSVERSAL CAP Trazo caligráfico. 4,5 cm Ø. (mín. 1,2 cm) 120 uds. MD1000215C 1000 uds. MD1000215B		 C1 HARDCORE FAT Trazo muy ancho. 12,5 cm Ø. (mín. 3 cm) 120 uds. MD1000233C 1000 uds. MD1000233B	
 C1 TRANSPARENTE UNIVERSAL Trazo fino - medio. 3 cm Ø. (mín. 1,4 cm) 120 uds. MD1000232C 1000 uds. MD1000232B		 C1 ASTRO FAT Trazo muy ancho. 12 cm Ø. (mín. 3 cm) 120 uds. MD1000222C 1000 uds. MD1000222B		 C1 HARDCORE FAT Trazo muy ancho. 12,5 cm Ø. (mín. 3 cm) 120 uds. MD1000233C 1000 uds. MD1000233B	
 C2 SUPER FAT CAP Trazo ancho. 8 cm Ø. (mín. 2,8 cm) 120 uds. MD1000211C 1000 uds. MD1000211B		 C1 ASTRO FAT Trazo muy ancho. 12 cm Ø. (mín. 3 cm) 120 uds. MD1000222C 1000 uds. MD1000222B		 C1 HARDCORE FAT Trazo muy ancho. 12,5 cm Ø. (mín. 3 cm) 120 uds. MD1000233C 1000 uds. MD1000233B	





Actitud “Low Cost”

Mucho antes de la aparición de las líneas aéreas “Low cost”, Montana Colors ya compartía esta idea fabricando pintura de alta calidad a precios muy ajustados. Transformamos para siempre el concepto de spray de pintura poniéndolo al alcance de todo el mundo.

Ahora abróchense los cinturones porque vamos a despegar.

Montana Colors, apoyando al graffiti desde 1994.

94
146 colores. Baja presión. Acabado mate.
Más información: www.montanacolors.com - www.myspace.com/montanacolors

DISTRIBUCIÓN EN ESPAÑA Y PORTUGAL: Spray Planet, S. L. T. (+34) 938 332 760 - F. (+34) 938 332 761 - info@sprayplanet.com - www.sprayplanet.com - Tienda Online



Actitud “Low Cost”

Mucho antes de la aparición de las líneas aéreas “Low cost”, Montana Colors ya compartía esta idea fabricando pintura de alta calidad a precios muy ajustados. Transformamos para siempre el concepto de spray de pintura poniéndolo al alcance de todo el mundo.



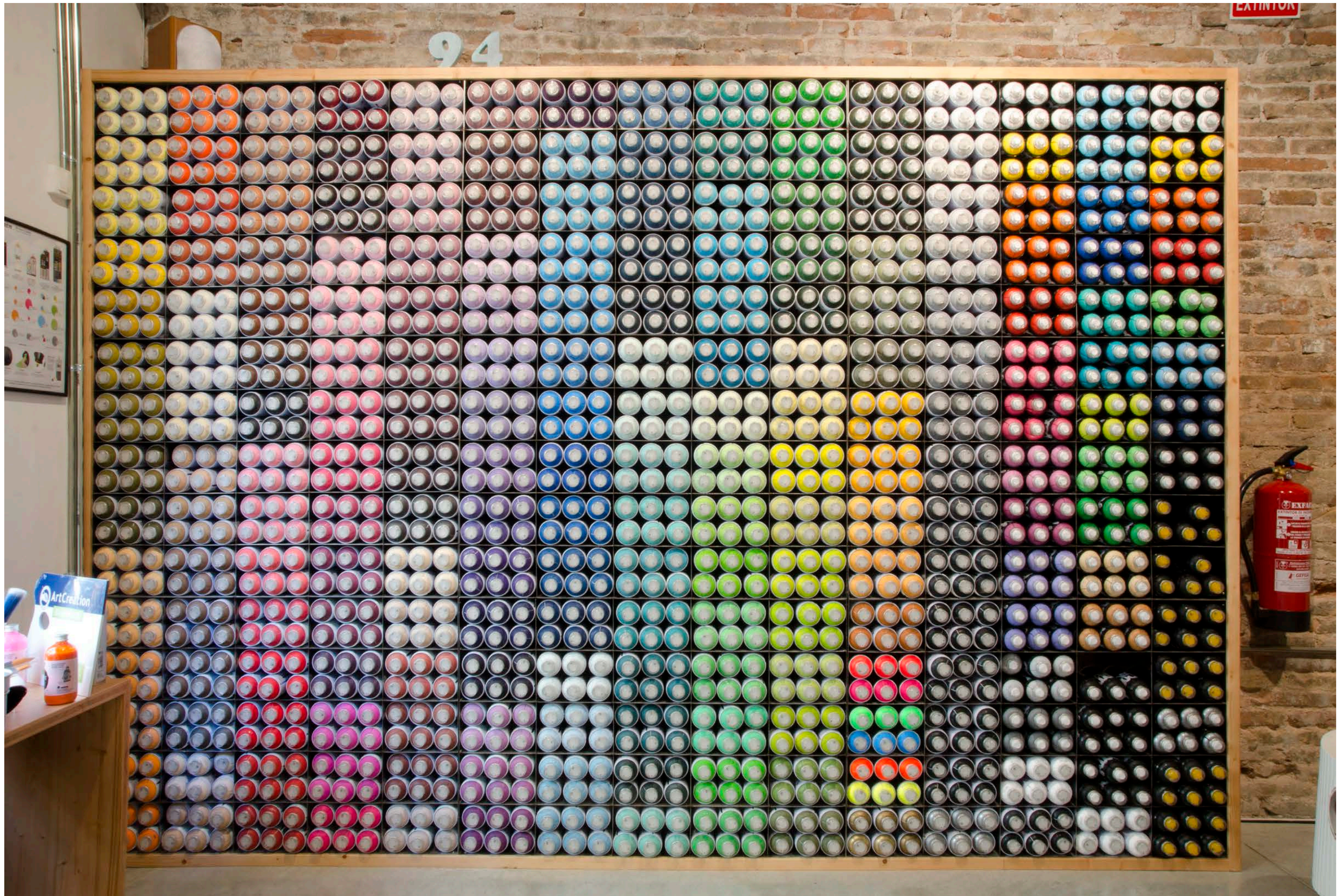



Montana Colors Made in Catalunya

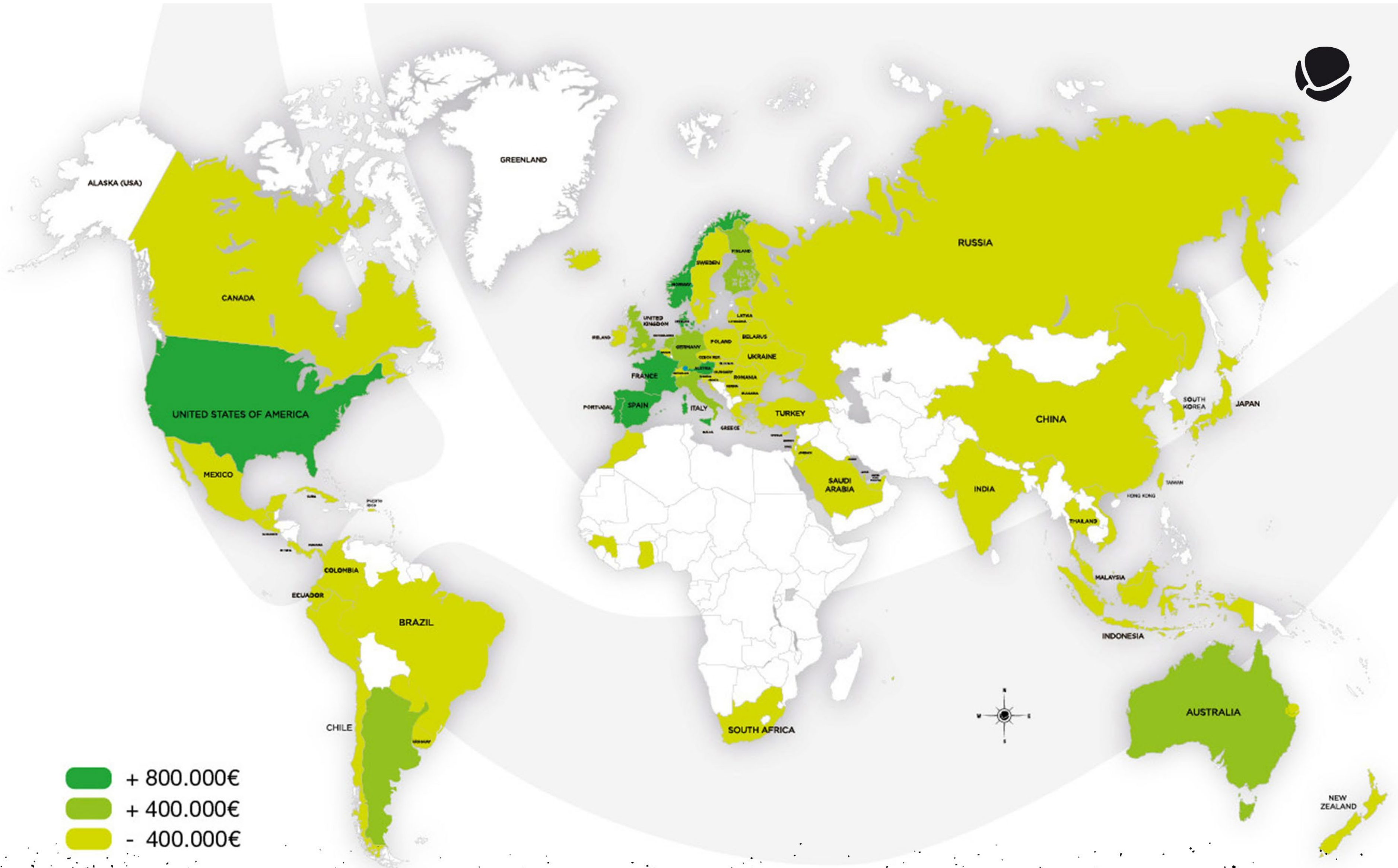



-  + 800.000€
-  + 400.000€
-  - 400.000€

2018

**Un equipo humano
de 206 personas**

96 mujeres

110 hombres

Edad media:

37 años

2014 — 170

2015 — 162

2016 — 184

2017 — 201

Salario más alto 80.000 €

Salario más bajo 20.000 €





Protege el medio ambiente. Sostenibilidad.

Montana Colors comprometida con el medioambiente y con las futuras generaciones. Todos nuestros productos MTN® cumplen las más altas exigencias medioambientales vigentes.

Los gases propelentes (butano / propano) son libres de CFC y los envases reciclables al 100%.



Montana Colors cumple con los siguientes standards de calidad, salud y ecología.



BY **montana colors**
THE ORIGINAL

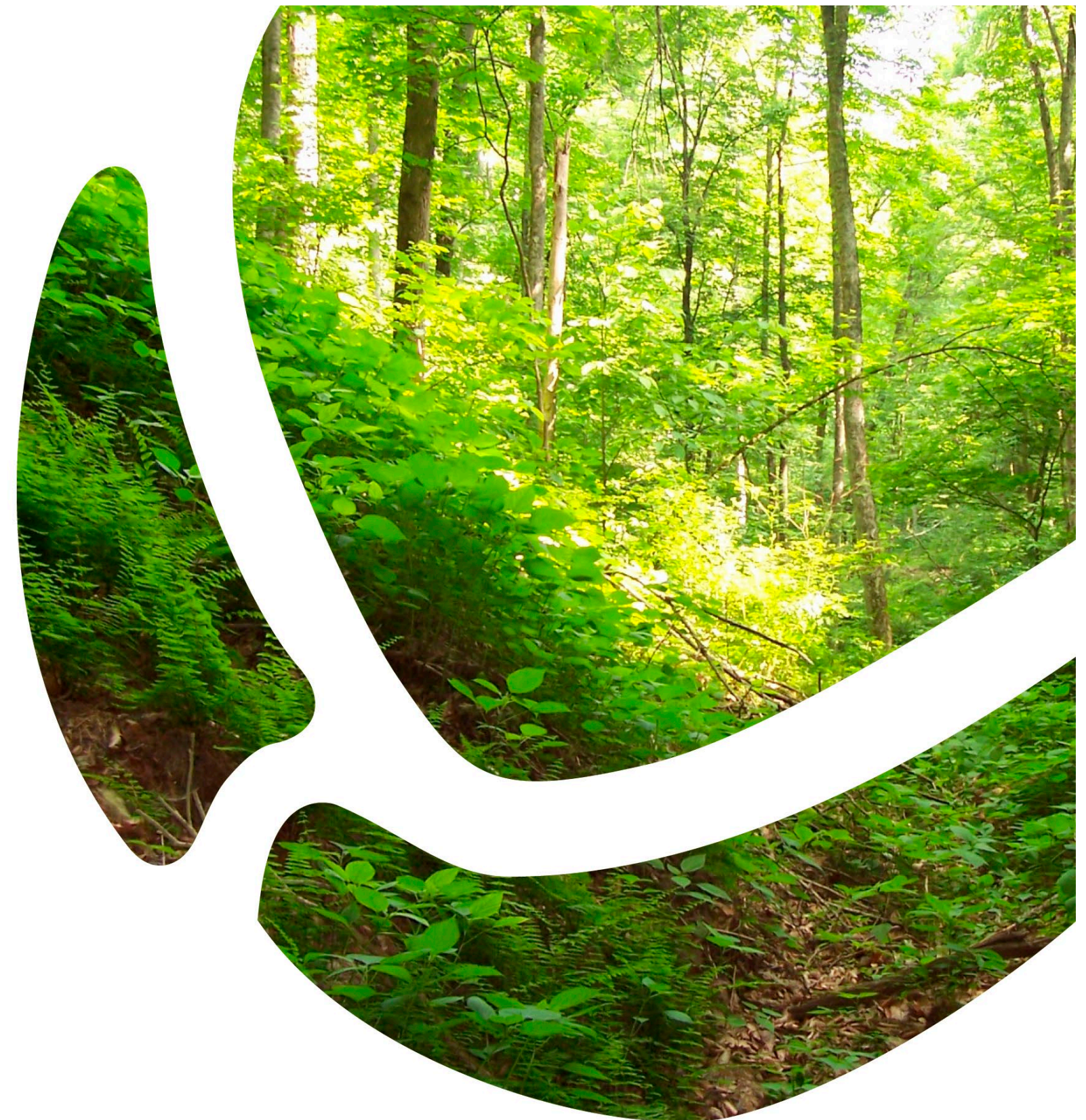

Protege el medio ambiente.

Deposita los envases MTN, una vez vacíos, en el contenedor amarillo de la recogida selectiva o en la papelera MTN de tu tienda habitual.

Montana Colors fabrica sus productos con componentes reciclables.

RECÍCLAME



PINTURA PAINT SPRAY



Distribución en España y Portugal: Montana Colors S.L.
T. (+34) 938 332 760 - F. (+34) 938 332 761 - pedidos@montanacolors.com
Tienda Online: www.sprayplanet.com



www.montanacolors.com



¿QUIÉN ES EL VÁNDALO?



montana
HARDCORE
ALIEN
PRODUCTS
mtn
www.montanacolors.com



MONTANA SHOP & GALLERY - BARCELONA
Comerc, 6 - 08003 - Barcelona
Tel/Fax: (+34) 93 268 0191
barcelona@montanacolors.com
(lunes a sábado de 11 a 14 y de 17 a 20:30)





KEEP
IT CLEAN
CLEAN

Central
de
Biomasa

Fon
d'Erer
Renova



Nuestros amigos - Tina y Valentí





Moltes gràcies!



Montana Colors
Supporting graffiti since 1994

Montserrat - Entorno de nuestra fábrica - Barcelona - Catalunya.